



**NETWORK  
TECHNOLOGIES  
INCORPORATED**

1275 Danner Dr    Tel:330-562-7070  
Aurora, OH 44202    Fax:330-562-1999  
www.networktechinc.com

## ***RACKMUX® Series***

# **RACKMUX-V15-4UNV**

# **RACKMUX-V15-8UNV**

# **RACKMUX-V17-4UNV**

# **RACKMUX-V17-8UNV**

## **KVM Drawer with Universal KVM Switch Installation and Operation Manual**



**TRADEMARK**

RACKMUX is a registered trademark of Network Technologies Inc in the U.S. and other countries.

**COPYRIGHT**

Copyright © 2007 by Network Technologies Inc. All rights reserved. No part of this publication may be reproduced, stored in a retrieval system, or transmitted, in any form or by any means, electronic, mechanical, photocopying, recording, or otherwise, without the prior written consent of Network Technologies Inc, 1275 Danner Drive, Aurora, Ohio 44202.

**CHANGES**

The material in this guide is for information only and is subject to change without notice. Network Technologies Inc reserves the right to make changes in the product design without reservation and without notification to its users.

## TABLE OF CONTENTS

INTRODUCTION .....	1
Models Available .....	1
Types of CPUs Supported .....	1
Features .....	1
MATERIALS .....	2
FEATURES AND FUNCTIONS.....	3
INSTALLATION .....	4
Rack Mounting Instructions .....	4
Connect The Cables .....	4
Power-Up Sequence.....	6
USING THE RACKMUX.....	7
Keyboard Control.....	7
OSD Control .....	7
Security Option .....	7
Enabling the Security Feature .....	7
User Login Mode.....	8
Additional Modes Available With Security .....	8
Administration Mode .....	8
Switch Configuration.....	9
Exit Switch Configuration Mode.....	9
Administrator Password .....	10
User Name List .....	10
System Access List.....	11
User Access Functions .....	11
Command Mode .....	11
Broadcast Mode.....	13
Scan Mode.....	13
Normal Mode .....	13
Edit Mode.....	13
Search Mode.....	14
Maintenance Mode .....	15
Help Mode.....	16
RS232 CONTROL.....	16
RS232 Connections and Configuration .....	16
Remote Connection .....	16
Configuration .....	17
Baud Rate .....	17
Loop Back.....	17
Unit Address .....	18
Exit Switch Configuration Mode.....	18
Command Protocol .....	18
Display Functions.....	21
Standard Controls.....	21
OSD Control Menu .....	21
OSD Main Menu .....	21
Brightness/Contrast Menu .....	22
Color Menu .....	22
Position Menu .....	22
Setup Menu.....	23
Keyboard Functions .....	24
RACKMUX-V15-x .....	24
Function Key Operation .....	24
Number Pad.....	25
Other Functions of the "Fn" Key .....	26
Numeric Keypad Option.....	27
KEYBOARD FEATURES .....	28
Keyboard-To-Computer Translation .....	28

Translation Capabilities .....	28
Translation Tables .....	28
TRUBLESHOOTING .....	29
DEFAULT PASSWORD RESET .....	29
Rackmux-KVM Drawer Standard Specifications.....	30
General Specs .....	30
LCD – 15” .....	30
LCD – 17” .....	30
Display Controller: VGA (-15 & -17) .....	30
OSD Control Board.....	30
Keyboard.....	31
Touchpad.....	31
INDEX.....	31
WARRANTY INFORMATION.....	31

## **TABLE OF FIGURES**

Figure 1- Mount RACKMUX to rack .....	4
Figure 2- Connect a PS/2 CPU .....	5
Figure 3- Connect a legacy SUN CPU .....	5
Figure 4- Connect the power cord and AC adapter .....	6
Figure 5- Administrator Login screen .....	7
Figure 6- User Login screen .....	8
Figure 7- Administration Mode menu .....	8
Figure 8- Switch Configuration Mode screen .....	9
Figure 9- Administrator password change .....	10
Figure 10- User Name List screen .....	10
Figure 11- Command Mode menus .....	12
Figure 12- Edit Mode screen.....	13
Figure 13- Search Mode screen .....	14
Figure 14- Maintenance Mode screen .....	15
Figure 15- Switch Configuration Mode screen .....	17
Figure 16- Daisy chain configuration with Matrix-Y-1 cable .....	17
Figure 17- Matrix-Y-1 wiring schematic.....	18
Figure 18- OSD Controls .....	21
Figure 19- US(English) Keyboard Layout .....	24
Figure 20- Keyboard LED Indications .....	24
Figure 21- Keys of the Number Pad .....	25
Figure 22- Additional multi-function keys .....	26
Figure 23- U.S. (English) keyboard with numeric keypad .....	27
Figure 24- U.K. (English keyboard with numeric keypad .....	27
Figure 25- German keyboard with numeric keypad .....	27
Figure 26- Locating the password reset button .....	29

## INTRODUCTION

The RACKMUX-V15-8UNV (**RACKMUX**) is a KVM Drawer with Universal KVM Switch that combines a rackmount 15" TFT/ LCD monitor, keyboard, touchpad mouse, an 8-port Universal KVM switch (**NODEMUX**) in a space-saving 1RU industrial strength drawer with wrist pads. The RACKMUX is equipped with a built-in switch function, which allows control of up to eight (8) Windows or SUN-enabled CPUs with a single keyboard, touchpad and monitor. When access to a server rack is needed, the drawer can be pulled out and the display lifted up like a notebook computer, revealing the keyboard and touchpad. When the drawer is not in use, the display can be folded forward and down so the 1RU drawer can be pushed into the cabinet easily and smoothly, helping to organize and streamline busy server rooms.

The onboard Universal KVM switch allows access to any Windows or SUN legacy CPUs from one monitor, keyboard and mouse (up to 8 CPUs). These CPUs can be file servers, network managers, etc. Internal microprocessor circuitry allows all CPUs to be booted simultaneously without keyboard error. Port selection is accomplished through On Screen Display (OSD) menus provided for switch control and security administration.

### Models Available

- RACKMUX-V15-4UNV - KVM Drawer with 15" TFT/LCD monitor and 4-port NODEMUX
- RACKMUX-V17-4UNV - KVM Drawer with 17" TFT/LCD monitor and 4-port NODEMUX
- RACKMUX-V15-8UNV - KVM Drawer with 15" TFT/LCD monitor and 8-port NODEMUX
- RACKMUX-V17-8UNV - KVM Drawer with 17" TFT/LCD monitor and 8-port NODEMUX

### Types of CPUs Supported

- PS/2 (i.e. WINxx)
- Legacy SUN
- USB (when used with NTI USB-PS2 or USB-SUN Adapter)

### Features

- Entire unit is only 1RU (1.75") high
- High-quality metal construction (ideal for most industrial and commercial settings)
- 15" or 17" Rack Mount LCD Monitor features a wide viewing angle
- 1024X768 resolution for 15" XGA monitor
- 1280x1024 resolution for 17" SXGA monitor
- A forward-folding 15" or 17" TFT LCD with built-in OSD menu for screen adjustments
- LCD Power-up when raised; manual override
- LCD Display controls (using on-screen menu)
- Includes rack mount kit suitable for SUN and most EIA 19" racks
- Fits varying rack depths from 22" to 39" deep via adjustable mounting brackets
- VGA/SVGA/XGA/SXGA Compatible
- Powered by 110-240VAC, 50 or 60Hz via IEC connector and country-specific line cord
- Auto shut-OFF switch: Turns OFF the power to the monitor when the LCD is in a folded-closed position
- Standard 3-button touchpad
- Added security with a drawer lock to prevent unwanted access
- Locking rails to prevent movement of the drawer when fully extended
- Keyboards available in multiple languages: English(US), English(UK), German, Italian, French, and Spanish

### Option:

- **Numeric keypad option**- for a separate 17-key numeric keypad, add "-N" to the part number (i.e. RACKMUX-V17-N-8UNV)

## MATERIALS

### Materials supplied with this kit:

- NTI RACKMUX-V15/17-4/8UNV KVM Drawer with Universal KVM Switch
- Line cord, country specific
- set of keys for keylock
- 2 Rear Mounting Brackets w/nuts
- 8 #10-32x3/4" screws and cage nuts for mounting to a rack
- CD with a pdf of this manual

### Materials *Not* supplied but **REQUIRED**:

- **A set of 2 cables for each CPU being connected to the switch:**
  - PS/2 CPU to Switch
    - VEXT-xx-MM for video interface
    - VKTINT-xx-MM for keyboard and mouse interface
  - Legacy SUN CPU to Switch
    - VEXT-xx-MM for video interface
    - 13W3M-15HDF (adapter for 13W3 to 15HD)
    - SKTINT-xx-MM for keyboard/mouse interface

where:

xx is the length of the cable in feet

MM indicates male-to-male connector

Cables can be purchased from Network Technologies Inc by calling **(800) 742-8324** (800-RGB-TECH) in the US and Canada or **(330) 562-7070** (worldwide).

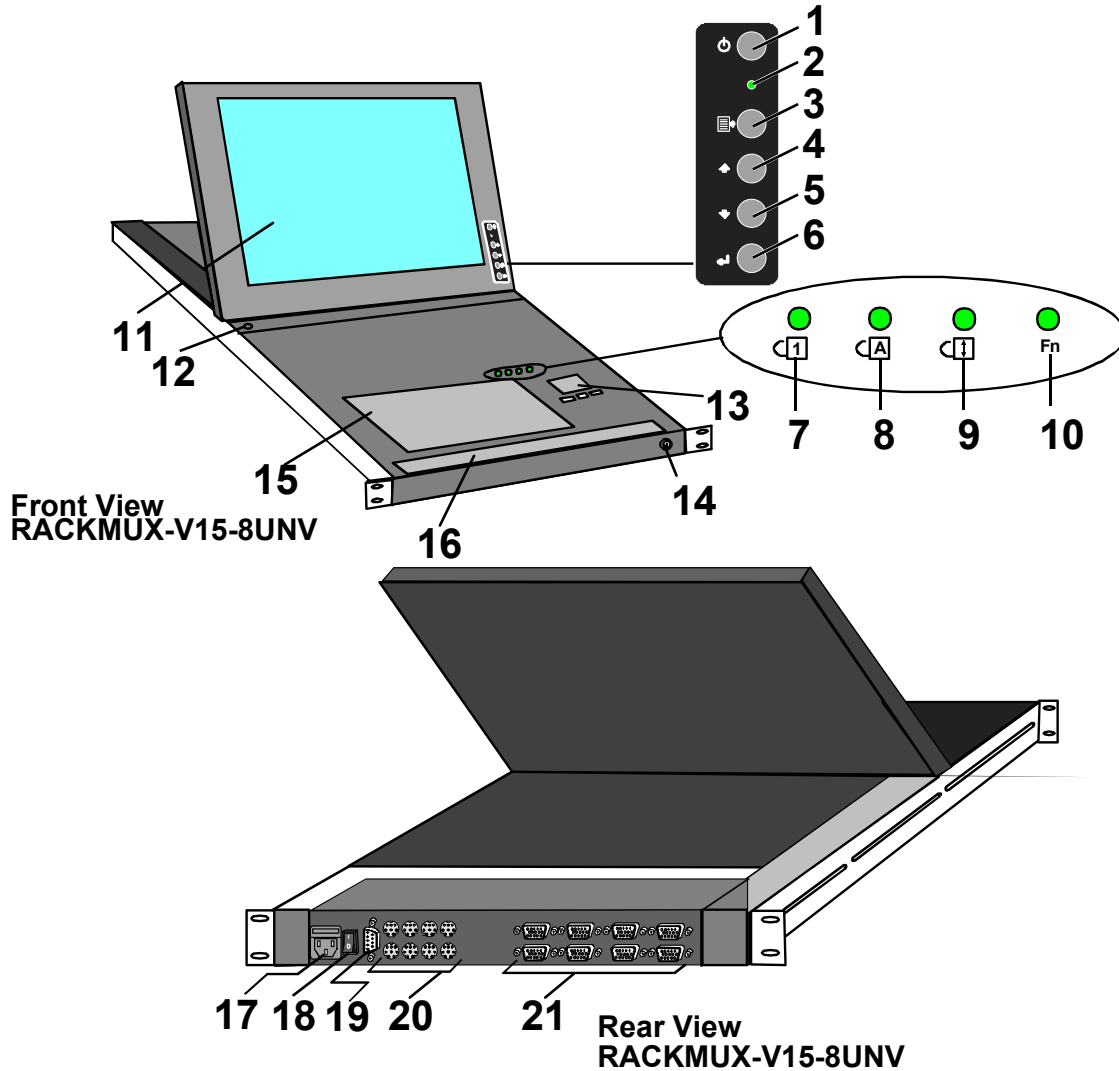

## FEATURES AND FUNCTIONS

1. **Power Button**- press to turn the LCD monitor ON and OFF
2. **Power LED**- Indicates operation status  
Green = Power-ON, Video Input Signal OK  
Red = Suspend / Stand-by, or no Video Input Signal
3. **Menu Button**- press to turn ON the OSD menu
4. **Up Arrow Button**- press to move the cursor in the OSD menu up
5. **Down Arrow Button**- press to move the cursor in the OSD menu down
6. **Select Button**- press to select a menu item (when OSD menu is ON) or press to auto adjust the video quality (when OSD menu is OFF)
7. **NumLock LED**- illuminates when the number lock is ON
8. **CapsLock LED**- illuminates when CapsLock is ON.
9. **Scroll Lock LED**- illuminates when the Scroll Lock keyboard feature is ON.
10. **Fn LED**- illuminates when Function Features (page 24) are enabled.
11. **LCD Display**- for viewing the video signal from the connected CPU
12. **Auto Shut-OFF**- switch automatically shuts OFF the LCD display when the monitor is folded down
13. **3-button touch pad**- for controlling mouse movements on the monitor and controlling the computer
14. **Keylock**- to prevent unauthorized use of the RACKMUX
15. **keyboard**- for manual data entry and computer control
16. **wrist rest**- for user comfort
17. **IEC Connector w/Built-in 2A 240VAC Replaceable Fuse**- for attachment of the IEC power cord to power the RACKMUX drawer
18. **Switch**- for powering ON and OFF the RACKMUX drawer
19. **RS232- 9D female connector**- for attaching RS232 interface cable from a remote terminal to control the functions of the NODEMUX switch
20. **CPU x**- 8 pin miniDIN female connector-for connection of device cable from CPU(s)
21. **VIDEO x**- 15HD female connectors- for connecting video cables from CPUs

# INSTALLATION

## Rack Mounting Instructions

The RACKMUX was designed to be mounted to a rack and includes mounting flanges to make attachment easy.

1. Determine the mounting height in the rack for the drawer. It should be a height comfortable to use the keyboard and see the LCD display. Mark holes in each of the 4 corner cabinet rails at points all level with each other.
2. Secure the rear brackets to the rear rack cabinet rails. Apply the top screws (not supplied) for each bracket to the holes marked in step 1.
3. Lift the keyboard into position and line the studs on the left and right sides up with the slotted openings in the rear bracket. Apply the nuts (supplied) to the studs but do not tighten the nuts yet.

**FYI:** There are 3 mounting studs provided on each side of the RACKMUX. Depending on the depth of the rack and distance apart of the cabinet rails, the position of the rear bracket may make all 3 studs available for use. In this case, apply the 2 nuts to the studs furthest apart from each other on each side.

4. Slide the drawer in until the top holes in the front bracket flanges line up with the holes marked in step 1. Secure the front brackets on the drawer to the front cabinet rails with two screws per bracket. Be sure to tighten the screws securely. Then tighten the nuts applied in step 3.
5. Apply one more screw to each of the rear brackets to finish.

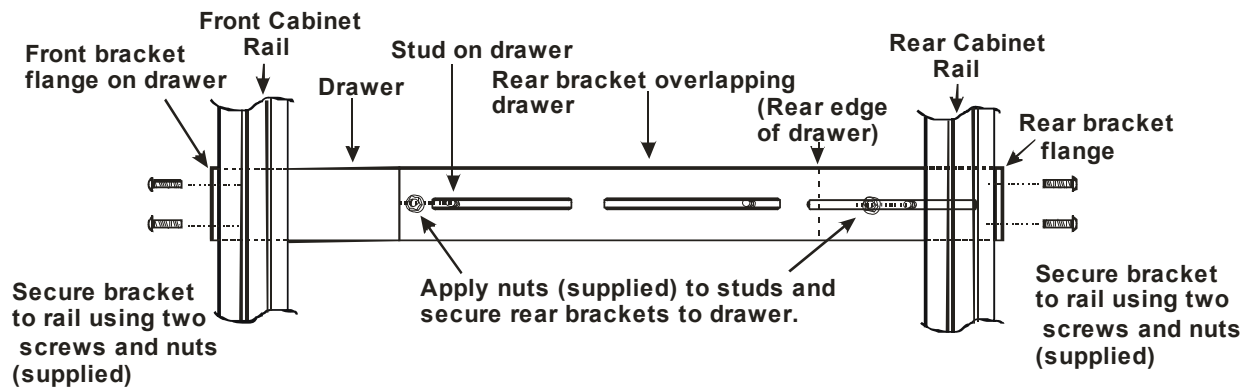

Figure 1- Mount RACKMUX to rack

## Connect The Cables

1. Turn OFF power to all CPUs that will be connected to the NODEMUX before connecting or disconnecting any cables to or from them.



**WARNING! DAMAGE MAY OCCUR TO THE CPU IF POWER IS NOT DISCONNECTED BEFORE CONNECTING OR DISCONNECTING CABLES.**

2. Connect the appropriate NTI keyboard cable (see the chart below) from the input devices port (keyboard/mouse) of a CPU to a CPUx port of the NODEMUX. Note the port's number. (See Figs. 2 and 3.)
3. Connect a VEXT-xx-MM video cable and video adapter, if needed (see the chart below), from the video port of the same CPU to the VIDEOx port of the NODEMUX with the same port number as the keyboard (see Figs. 2 and 3).

CPU	Keyboard Cable	Video Cable	Video Adapter
PS/2	VKTINT-xx-MM	VEXT-xx-MM	None needed
SUN	SKTINT-xx-MM	VEXT-xx-MM	15DM-15HDF

**NOTE: Make sure the CPU is connected to a CPU x port and a VIDEO x port with the same number.**

•**PS/2 CPU-** Connect a PS/2 CPU video port using a VEXT-xx-MM cable between a VIDEOx port on the NODEMUX and the CPU. Connect the PS/2 CPU keyboard and mouse ports using a VKTINT-xx-MM cable between a CPUx port on the NODEMUX and the CPU. (See Fig.2.)

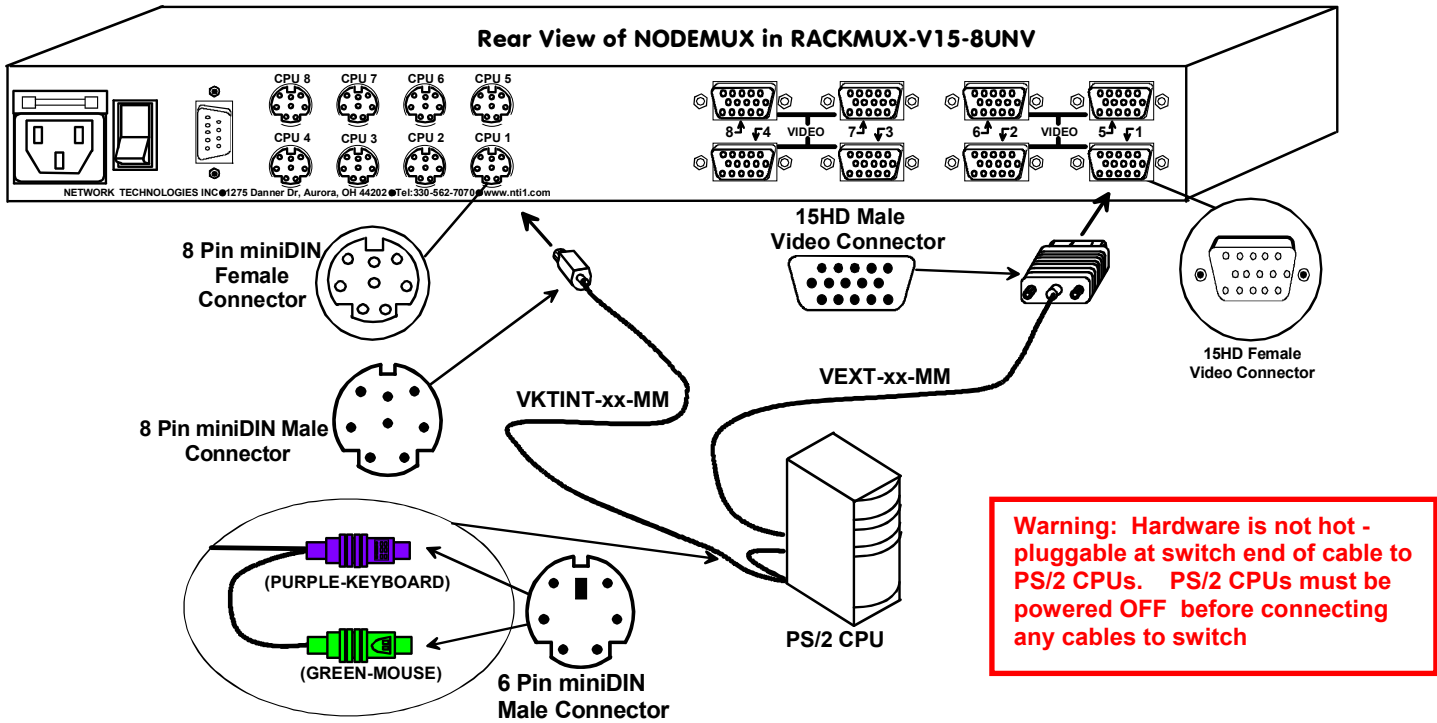

Figure 2- Connect a PS/2 CPU

•**SUN CPU-** Connect a SUN CPU video port using a VEXT-xx-MM cable with a 13W3M-15HDF adapter between a VIDEOx port on the NODEMUX and the CPU. Connect the SUN CPU keyboard/mouse port using an SKTINT-xx-MM between a CPUx port on the NODEMUX and the CPU. (See Fig. 3.)

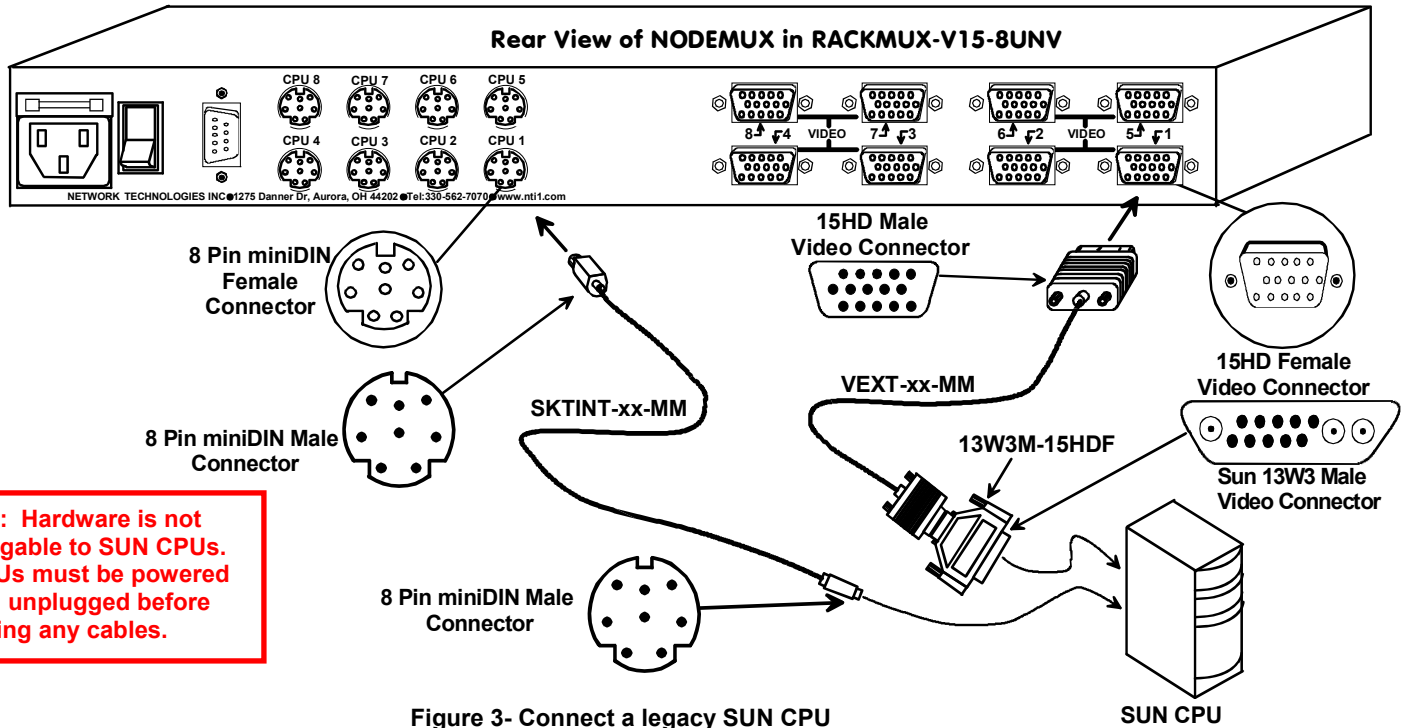

Figure 3- Connect a legacy SUN CPU

4. Connect the remaining input device and monitor interface cables from each CPU, making sure that cables from the each CPU are connected to the NODEMUX switch at connectors with the same port numbers ("CPU 1" and "VIDEO 1" connectors, "CPU 2" and "VIDEO 2" connectors...etc. )
5. Connect the power cord to the IEC connector.

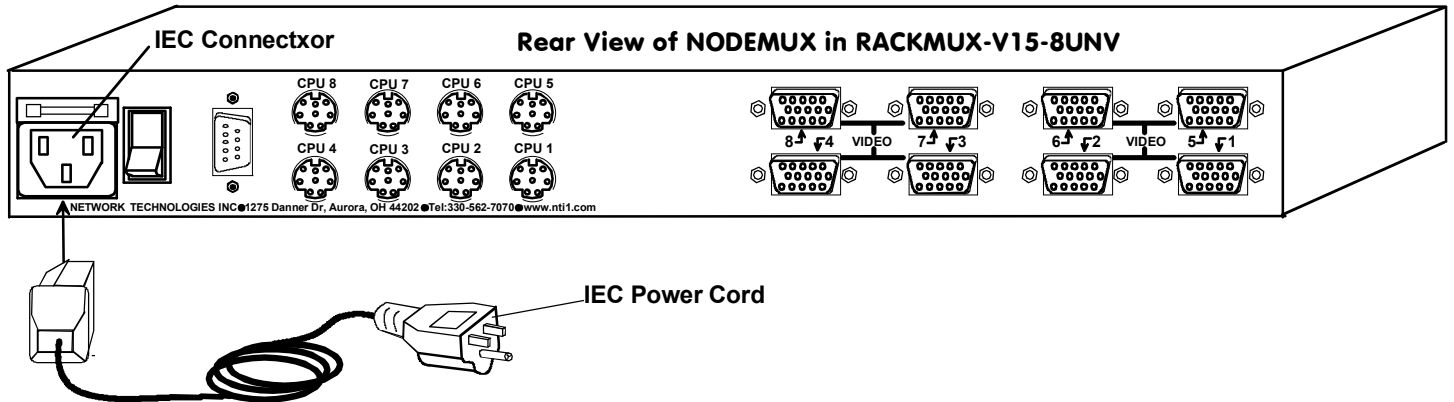

Figure 4- Connect the power cord and AC adapter

## Power-Up Sequence

**Note: It is very important that this power-up sequence be followed for all connected components to work properly.**

1. Using the key, unlock the drawer and slide the keyboard and LCD Display out far enough to raise the display to a comfortable viewing angle.
2. Power ON the NODEMUX with the power switch located at the rear of the RACKMUX.
3. Power ON the KVM Drawer with the power switch located at the rear of the keyboard.
4. Adjust the screen's brightness and contrast with the controls also located on the monitor– as needed.
5. Power ON any attached CPUs.

## USING THE RACKMUX

Once the RACKMUX is properly connected, the NODEMUX will enable a connection to be made between the attached CPUs and the monitor, keyboard, and mouse.

The NODEMUX can be controlled by three methods:

- keyboard control through Command Mode
- mouse clicks from within some menus of Command Mode
- RS232 control from a remote terminal

## Keyboard Control

Keyboard control of the NODEMUX is achieved using Command Mode - operated using the keyboard and mouse in conjunction with OSD menus superimposed onto the monitor.

By pressing <Ctrl> + <`> (accent key), the user can enter Command Mode. Once in Command Mode, typing a series of commands will cause the NODEMUX to connect the user to any one CPU connected to the switch. Pressing the <Esc> key will exit Command Mode. The following instruction describes how to use the menus to operate the NODEMUX Universal KVM switch.

## OSD Control

OSD superimposes a menu system on the user's video screen with a list of all connected CPUs. OSD allows CPUs to be named (with up to 12-character names). OSD then allows selection of CPUs by that name. Connected CPUs can be listed by name or by port number. OSD Search Mode enables the user to type in the first few characters of the CPU's name and the OSD will locate it. Help screens assist with all OSD functions.

## Security Option

The security option of the OSD Control enables an administrator to control access to CPU ports for each user. Up to 63 users can be created. These users have controlled access to any selected CPU. Only the administrator can activate or deactivate the security features. Security can be activated from the Maintenance Mode menu (page 15) with a successful administrator login for verification purposes. Furthermore, the administrator can set a maximum idle time value after which the current user will be logged out and the login screen displayed. This time out does not function while the OSD is active. The current security status, idle time out, and scan dwell time are all saved and will be restored whenever power to the switch is cycled OFF, then ON.

If the security option is enabled, when the RACKMUX is powered up the user will be prompted for a username and password to continue. If the security option is not enabled the monitor will display the desktop image for the connected CPU and the user can continue with normal operation of the connected CPU.

## Enabling the Security Feature

To enable the security feature the administrator must first enter Command Mode from the keyboard using the sequence <Ctrl> + <`> (accent key). The OSD menu will automatically appear on the monitor. This provides a visual way to control the NODEMUX using the keyboard and mouse.

**The administrator**, when setting the NODEMUX switch up for the first time, may want to proceed directly to the ADMINISTRATION Mode by typing <CTRL> +<M>, then <A>, and then <Y>.

The factory settings are:

- **default user name = ADMINISTRATOR**
- **default password = ADMINISTRATOR**

**Note:** The user name for the administrator cannot be changed from "ADMINISTRATOR".

Once logged-in, follow the instructions on page 10 for setting up users and changing the password. Within the Administration Mode the administrator can setup each of the users and the limitations of their use of the individual CPUs attached to the switch.

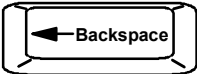



Figure 5- Administrator Login screen

**When a standard user powers up the system a security screen will appear if security has been enabled by the administrator.** The user will need to login to the switch by following the instructions below for the USER LOGIN. If the user does not know the appropriate user name and password (setup by the administrator), contact the switch administrator for this information. Once logged-in a user can follow the Command Mode functions described on page 9 to control the switch within the limitations as determined by the administrator.

### User Login Mode

User login mode requires a user to login with a user name and password from the list created by the administrator. This mode will also disable use of the front panel until the user logs in.

Function:	Keystroke:
Adds a character to the user name/password	 (Type any alphabetical or numeric character)
Removes previous character from the user name/password	
Submit user name/password	
Exit USER LOGIN and return to previous mode. This function is only available if security is not currently active.	

*If the password submitted is incorrect, the user will not be able to proceed.*

*If the password submitted is correct, the user will proceed to Normal Mode.*



Figure 6- User Login screen





### Additional Modes Available With Security

The three modes that follow are only available if the administrator is logged in.

### Administration Mode

To enter the Administration Mode menu press <A> from the Maintenance Mode menu (page 15).

Administration Mode allows the administrator to use the following functions:

Function:	Keystroke:
Configure switch- for application and RS232 communication	
Change the administrator's password	
Disable security	
Update User Name List	

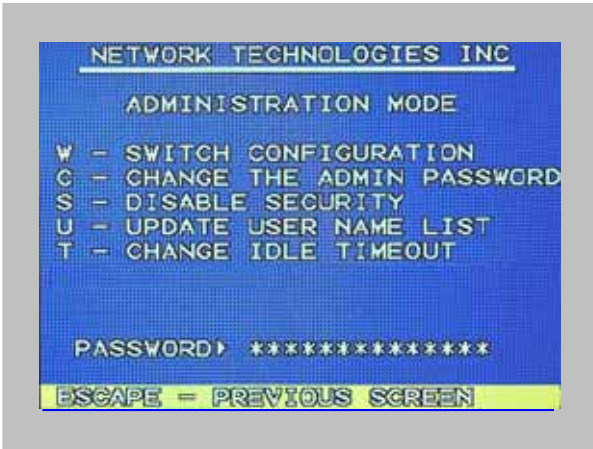

Figure 7- Administration Mode menu

**Administration Mode (Cont'd)**

**Function:**

**Keystroke:**

Selects the idle time in minutes

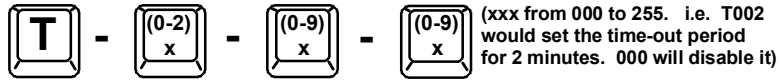

Exit Administration Mode and return to previous mode



**Switch Configuration**

Switch Configuration enables the administrator to configure the NODEMUX to be used as a stand alone switch or as one of the switches in a cascaded system. Switch Configuration is also used to setup the communication settings for RS232 communication with a remotely connected terminal through the RS232 port.

**Note:** When used in a RACKMUX, the NODEMUX can only be used as a stand alone switch. Do not change this setting.

**In the event the setting is changed from "stand alone" to "slave", when the switch is power cycled the OSD menu will no longer work. To change it back to a "stand alone" switch, factory default settings must be restored via a terminal connected to the RS232 control port. See RS232 Control on page 16 for how to restore default settings.**

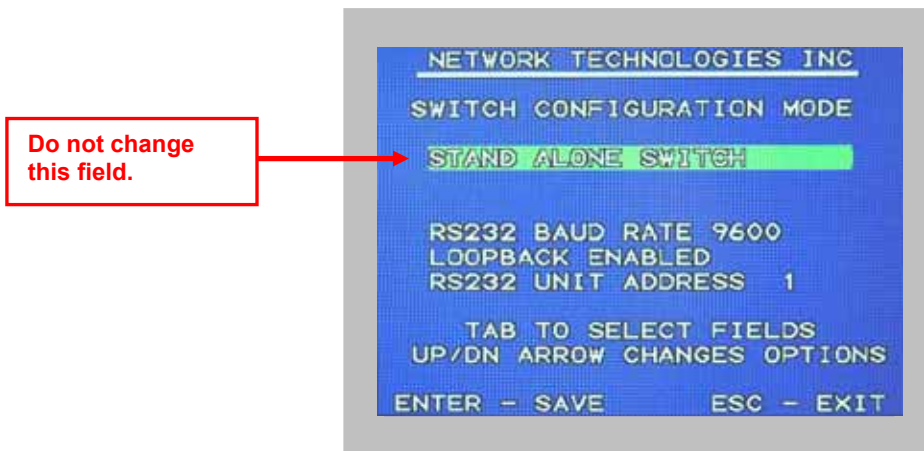

**Figure 8- Switch Configuration Mode screen**

For more on configuring RS232 control, see "RS232 Control" on page 16.

**Exit Switch Configuration Mode**

Once changes are made to the Switch Configuration menu, press <Enter> and <Y> to save them.

To exit **without saving**, press <Esc>, then <N>, then <Esc> again. The menu will return to the Administration Mode without saving the changes made. .

Changes made will take effect the next time the NODEMUX is power cycled.

## Administrator Password

To change the administrator password press <C> from the Administration Mode menu.

The administrator is able to change the administrator password as needed (see Fig. 9). Two edit fields are available, one for password, the other for verify password. The password can be up to 13 characters in length.

**Note: The default password for the administrator is ADMINISTRATOR.**



Figure 9- Administrator password change

### Function:

### Keystroke:

Add character to password string or verify password string

 **or**  +  (Type any upper or lower case alphabetical or numeric character)

Delete previous character in edited string



Save new password.

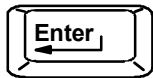

(If Password string and Verify Password string are different, this command will have no effect, enabling the administrator to correct the password)

Move to next field to be edited

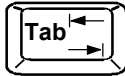

Return to Administration Mode



*FYI: Once the password is setup, if the password is lost or forgotten, see page 28 for instruction on how to reset the password to the default password.*

## User Name List

To enter the User Name List press <U> from the Administration Mode menu.

The User Name List displays the list of users and provides control for adding new users (up to 63), changing or assigning user passwords, and changing access rights for any given user. User names may be up to 12 characters long, may not contain spaces, and are not case sensitive. Passwords may be up to 15 characters long, may not contain spaces, and are case sensitive.

### Function:

### Keystroke:

Edit the highlighted user's System Access rights

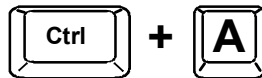

Enter Edit Mode to add/change/remove users

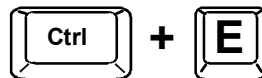

Change the highlighted user's password

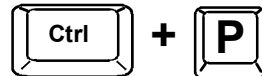

Exit the User Name List and return to previous mode



Figure 10- User Name List screen

## System Access List

The System Access List (accessible from the User Name List- page 10) displays a list of numbers representing the ports. From this screen the administrator can change access rights to the ports for the selected user. The user's name is displayed at the top of the access list for reference. The mouse is used to change access rights by clicking on a given number to toggle a port's status. A user that has access to a port can connect to that port and control the CPU connected to that port when in Normal Mode.

**Function:**

**Keystroke:**

Save the changes to the access list and return to previous mode

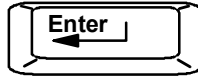

Exit the System access list without saving and return to previous mode.



## User Access Functions

### Introduction

The OSD menu enables a user to name the CPUs connected to the NODEMUX switch and connect to them using that name. The OSD is positioned on the monitor, displaying 8 CPU names at a time. The screen can be used for switching as well as editing the CPUs' names. Through the OSD menu, the user can operate the NODEMUX switch to have the switch cycle through 3 extended modes of operation: COMMAND, BROADCAST, and SCAN .

### Command Mode

When entering the Command Mode from the keyboard using the <Ctrl> + <^> (accent key), the OSD menu will automatically appear on the monitor. This provides a visual way to control the NODEMUX switch.

The list below describes the OSD Command functions available from the keyboard after entering Command Mode:

**Function:**

**Keystroke:**

Select the previous port



Select the next port



Enable/disable Scan Mode

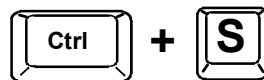

Enable/disable Broadcast Mode

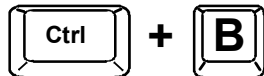

Enter Edit Mode

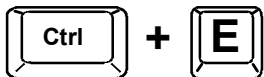

Enter Maintenance Mode

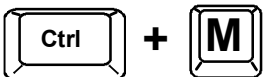

**Note:** The user must be logged in as administrator to access Edit Mode

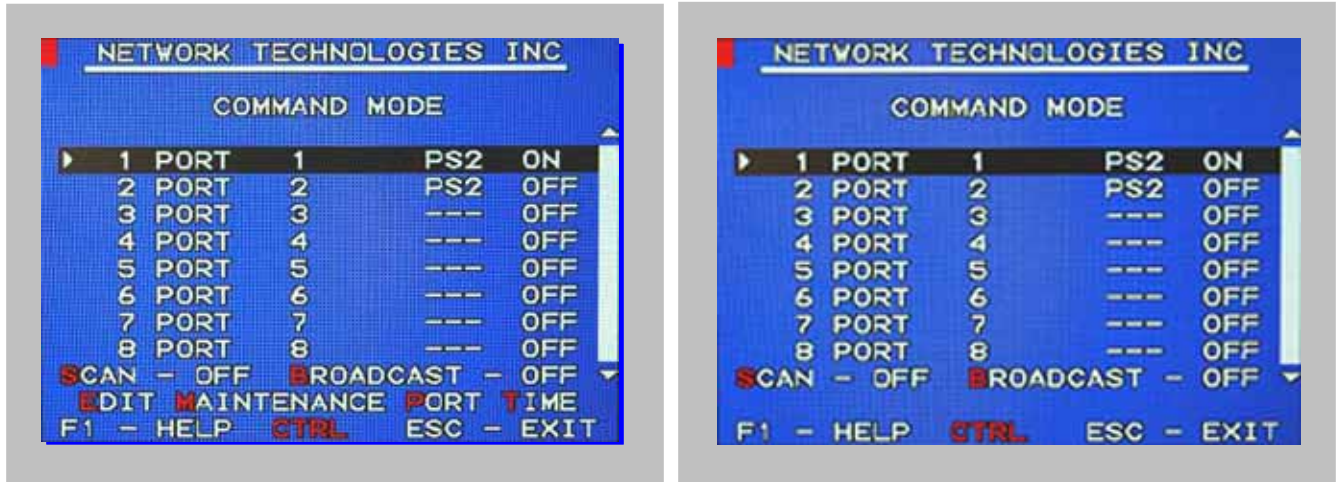

Figure 11- Command Mode menus

**Command Mode (Cont'd)**

**Function:**

**Keystroke:**

Sets scan time-out on each port

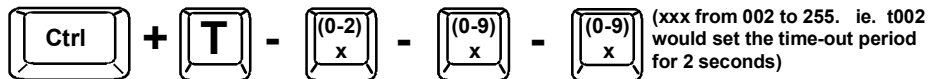

Selects a specific port

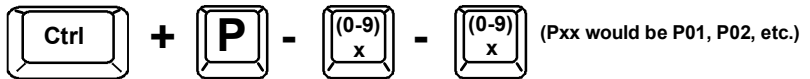

Enters Search Mode and adds a character to search string and selects the CPU's name that matches best.

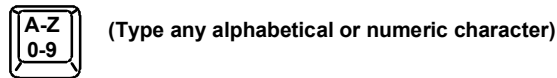

Selects the first port on the switch



Selects the last port on the switch



Display Help Menu



Switch to a selected port



Exit OSD Command Mode



Press <CTRL> while in the Command Mode menu to display the Edit, Maintenance, Port, and Timeout control features.

**Note:** The user must exit Command Mode to type to a CPU.  
  
To exit Command Mode, either hold down any touch-switch on the front panel for more than 2 seconds, OR press <ESC> on the keyboard.

The mouse can also be used to control the NODEMUX switch within the Command Mode menu.

- The mouse cursor can be moved to the Scan, Help, Broadcast, Timeout, Maintenance and Exit fields where the user can then click on the left mouse button to perform that function.
- Ports listed on the screen can be selected by moving the cursor onto that port and clicking. Clicking twice on a selected port will switch to that port and exit Command Mode.
- To change the displayed ports on the screen simply click on the up and down arrows located to the right of the port names displayed.

## Broadcast Mode

To activate Broadcast Mode press <Ctrl> + <B> from the Command Mode menu.

**(use with extreme caution or commands intended for one CPU will be sent to all CPUs)**

Broadcast Mode allows the operator to send keystrokes to all active CPUs simultaneously (even those CPUs the user cannot connect to due to lack of security access).

However, Broadcast Mode has some critical requirements:

- BROADCAST mode must be OFF when booting any attached CPUs.
- BROADCAST mode must be ON and COMMAND MODE must be OFF for keystrokes to reach attached CPUs.

**NOTE: The user must type somewhat slowly when in Broadcast Mode (less than 20 wpm) and cannot use the <Backspace> key.**

Broadcast Mode is not supported by any ports that have MAC CPUs attached.

## Scan Mode

To activate Scan Mode press <Ctrl> + <S> from the Command Mode menu.

When in Scan Mode the switch scans to each port with a CPU powered-ON. The port with the CPU powered-ON remains active while in use. When the switch becomes idle for the configured time-out period (default time-out period is 5 seconds) the switch will connect to the next powered-ON CPU port. See Command Mode section (page 11) for configuring the scan time-out period for each port.

**Note: The keyboard and mouse must remain idle for the full scan dwell time before the switch selects the next active port.**

**Note: The scan dwell time set by the user only effects that user and has no effect on other switch users.**

## Normal Mode

When the NODEMUX switch is not in Command, Broadcast, or Scan mode, the user is in Normal Mode, controlling the CPU to which the user is connected through the NODEMUX switch.

## Edit Mode

To activate Edit Mode press <Ctrl> + <E> from the Command Mode menu.

Edit Mode enables the user to modify the names of the CPUs connected to the switch. Names of CPUs can be up to 12 characters in length. When in Edit Mode, multiple keystroke combinations are not valid (<Shift>+P, <Ctrl>+P, <Alt>+ P, and P will all type a "P" to the display - lower case letters cannot be typed).

### Function:

### Keystroke:

Move cursor one position to the right



Move cursor one position to the left



Move cursor to the previous port



Move cursor to the next port



Selects the first port on the switch



Figure 12- Edit Mode screen

**Edit Mode (Con'td)**

**Function:**

**Keystroke:**

Selects the last port on the switch



Toggles between insert and overstrike



(The character either gets inserted and the remainder of the name gets shifted to the right, OR the current character gets overwritten.)

Erase current character



Erase previous character

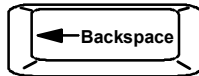

When finished making changes in Edit Mode, press <Enter> and a prompt will appear to press either <Y> to save the changes or <N> to continue making changes without saving the changes just made. If the <Esc> key is pressed instead of <Enter>, all changes made will be ignored and the display will return to the previous menu.

**Search Mode**

To enter Search Mode, type any alphabetical or numeric character when the Command Mode menu is on the monitor.

**Search** Mode enables the user to enter and maneuver through a list of CPU names. The CPU name best matching the characters typed is selected. The list of CPUs may also be searched for a specific (or similar) name. The following commands are valid when the search option has been invoked from Command Mode.

**Function:**

**Keystroke:**

Erase previous character in search name

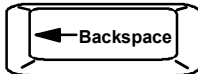

Move cursor one position to the right in search name



Move cursor one position to the left in search name



Select previous port



Select next port



Add a character to the search string and select the best matching CPU name



(Type any alphabetical or numeric character)

Exit Search Mode, return to Command Mode



Switch to selected port





Figure 13- Search Mode screen



## Help Mode

To enter Help Mode press the <F1> key from the Command Mode menu (page 11).

Help Mode displays a list of commands with a short explanation of their function. These lists are organized in pages for each mode (i.e. COMMAND, EDIT, and SEARCH). The following options enable the user to quickly obtain information on any command.

Function:	Keystroke:
View the previous page of help if available	
View the next page of help if available	
Exit HELP and return to previous mode	

## RS232 CONTROL

The NODEMUX can be configured to be controlled by a remote terminal connected through the RS232 port at the rear of the NODEMUX. For RS232 communication with a remote terminal to work, the NODEMUX must first be configured for the baud rate and address.

## RS232 Connections and Configuration

### Remote Connection

The RS232 Interface is designed to meet the RS232C standard and can be controlled from any CPU or other controller with an RS232 communications port. The pin-out for the DB-9 connector on the unit is as follows:

**RS232 Connector (DB-9 FEMALE)**

PIN	SIGNAL	FUNCTION
1	CD	Carrier Detect
2	TXD	Transmit data (RXD at host)
3	RXD	Receive data (TXD at host)
4	DTR	Data terminal ready
5	GND	Signal ground
6	DSR	Data set ready
7	RTS	Request to send
8	CTS	Clear to send
9	-	No connection

**Note: Security must be disabled or user access granted on the port(s) to be selected by RS-232 control.**

On the DB-9 female connector, pins 1 (DCD), 4 (DTR), and 6 (DSR) are shorted and pins 7 (RTS) and 8 (CTS) are shorted. Therefore, host handshaking is bypassed and TXD and RXD are the only active signals. A straight through DB-9 cable (not null modem) will work for most CPUs. To daisy chain multiple units, a Matrix Y-1 cable is used (see page 17) for each NODEMUX in the chain.

## Configuration

### Baud Rate

In order for a terminal to communicate with the NODEMUX, the terminal and NODEMUX must each be configured for the same baud rate.

Press <W> from the Administration Mode menu (page 8) to enter Switch Configuration mode. (Fig. 15)

Press <Tab> once to move the cursor bar to highlight "RS232 BAUD RATE". The default setting is 9600.

Press <Up Arrow> or <Down Arrow> to change the selected baud rate to 300,600,1200,2400,4800, or back to 9600.

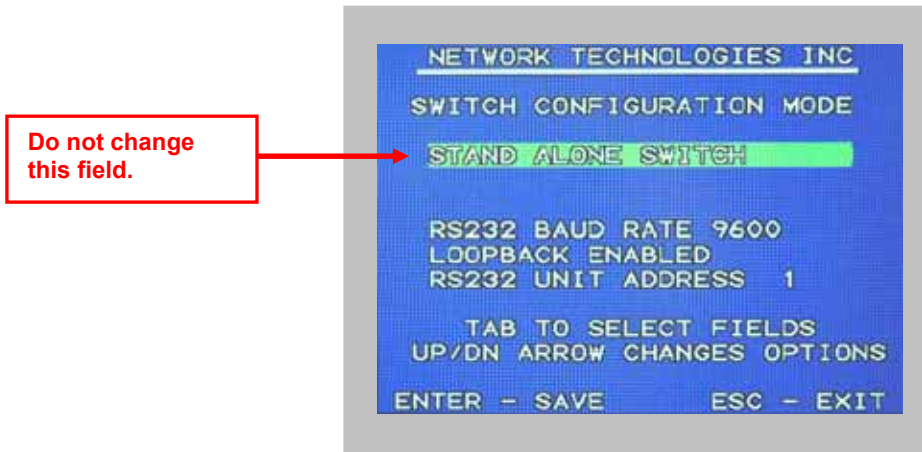

Figure 15- Switch Configuration Mode screen

**Note:** When used in a RACKMUX, the NODEMUX can only be used as a stand alone switch. Do not change this setting.

**In the event the setting is changed from "stand alone" to "slave", when the switch is power cycled the OSD menu will no longer work. To restore the setting back to "stand alone", factory default settings must be restored via a terminal connected to the RS232 control port. See the RS232 Command "CF" on page 19 to restore default settings.**

### Loop Back

In order for an RS232 command and a response to the command to be viewed at the terminal screen, the NODEMUX must have its Loop Back feature enabled.

More than one NODEMUX may be connected to a terminal at a time. To do so, a Matrix-Y-1 cable (available from NTI) must be used. (See Fig. 16). For each additional NODEMUX connected, another Matrix-Y-1 cable will be required.

If the NODEMUX is one of two or more switches being controlled via RS232, and if the NODEMUX is not that last switch in the series of switches controlled, then this setting should be changed to "DISABLED".

If the NODEMUX is the only device controlled via RS232, or if it is the last device in a series of devices being controlled, then this setting should remain "Enabled". (See Figure 16)

To enable or disable loopback, from the Switch Configuration mode menu (above),

press <Tab> until the cursor bar moves to highlight "LOOPBACK".

Press <Up Arrow> or <Down Arrow> to enable or disable loopback as needed for the application.

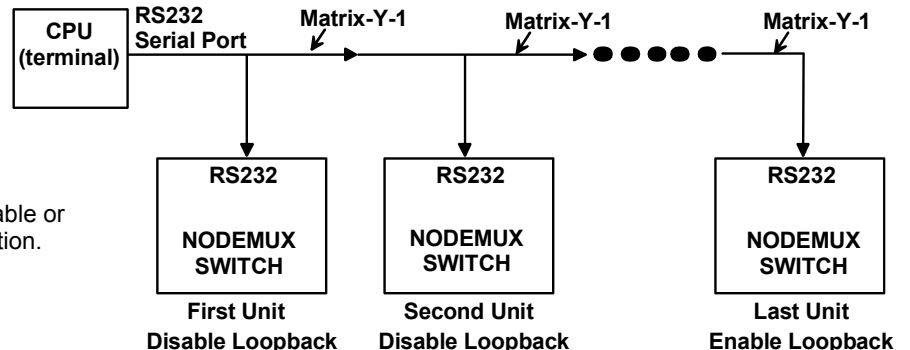

Figure 16- Daisy chain configuration with Matrix-Y-1 cable

### Wiring Schematic of Matrix-Y-1 cable

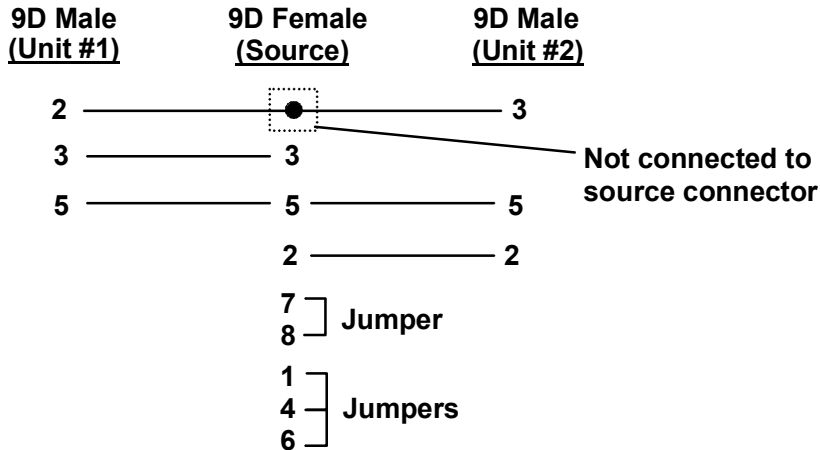

Figure 17- Matrix-Y-1 wiring schematic

### Unit Address

In order for a terminal to communicate with one or more NODEMUX switches, each switch must have a unique address. The NODEMUX will only respond to commands from a terminal if its address is embedded in the command. Up to 15 NODEMUX switches can be connected in a "daisy chain" to a terminal, each with its own unique address.

To set the address of the NODEMUX, from the Switch Configuration mode menu (Fig. 15 on page 17), press <Tab> until the cursor bar moves to highlight "RS232 UNIT ADDRESS". press <Up Arrow> or <Down Arrow> until the desired address (1-15) is selected.

### Exit Switch Configuration Mode

Once changes are made to the Switch Configuration menu, press <Enter> and <Y> to save them.

To exit without saving, press <Esc>, then <N>, then <Esc> again. The menu will return to the Administration Mode without saving the changes made. .

Changes made will take effect the next time the NODEMUX is power cycled.

## Command Protocol

Terminal control commands supported by the NODEMUX are defined below.

#### Notes:

- All commands should be terminated with an <Enter> (ASCII 13) denoted by <CR>. When a command is sent, the entire string is echoed back to the terminal along with a response from the addressed unit as shown in the command definitions. Unit response will be sent within 500 msec after <CR>.
- All characters should be upper case, and all numbers below 10 should have a leading 0 (ex: 1 = 01).
- For units with one USER port (i.e. this NODEMUX switch), use 01 for the USER select.

### RS - reset unit(s) to default power-up switch connections

FORMAT: RS AA<CR>  
RS = "reset unit" command followed by at least one space  
AA = unit address; if 00, all units on the bus will be reset and no response will be returned

RESPONSE: \*<CR> if command received and executed OK  
-OR-  
?<CR> if syntax or transmission error occurred

**Note: The RS command does not change the switch configuration, it changes CPU-to-user connection settings.**

### CS - change single USER channel

FORMAT: CS AA,XX,YY<CR>  
CS = "change single output" command followed by at least one space  
AA = unit address  
XX = input/CPU to connect  
YY = output/USER to change

RESPONSE: \*<CR> (command received and executed OK)  
-OR-  
?<CR> (syntax or transmission error occurred)

### CA - change all output channels

FORMAT: CA AA,XX<CR>  
CA = "change all outputs" command followed by at least one space  
AA = unit address  
XX = input /CPU to connect to all outputs/USERS

RESPONSE: \*<CR> (command received and executed OK)  
?<CR> (syntax or transmission error occurred)

**FYI: In this NODEMUX switch, this command will have the same effect as the CS command above.**

### RO - read single USER channel

FORMAT: RO AA,YY<CR>  
RO = "read output" command followed by at least one space  
AA = unit address  
YY = output/USER to read

RESPONSE: \*<CR> (command received and executed OK)  
XX<CR> (XX = input/CPU connected)  
-OR-  
?<CR> (syntax or transmission error occurred)

### RU - read unit size

FORMAT: RU AA<CR>  
RU = "read unit size" command followed by at least one space  
AA = unit address

RESPONSE: \*<CR> (command received and executed OK)  
XX,YY<CR> (XX = # of CPU's, YY = # of USERS)  
-OR-  
?<CR> (syntax or transmission error occurred)

RV- read unit software version

FORMAT:       RV XX,00  
              RV= "read software version" command followed by at least one space  
              AA= unit address  
              00= command for the address location in memory of the software version

RESPONSE:

**-OR-**

?<CR> (syntax or transmission error occurred)

CF - reset all connected units, regardless of address, to factory default configuration settings

**WARNING: THIS COMMAND WILL RESET ALL RS232 DAISY-CHAIN-CONNECTED NODEMUX SWITCHES TO FACTORY DEFAULT SETTINGS. IF OTHER SWITCHES ARE DAISY CHAINED VIA RS232, DISCONNECT THEM BEFORE SENDING THIS COMMAND.**

FORMAT:       CF 00

RESPONSE: (After 10-20 seconds)  
              COMMAND OK  
              RESET SWITCH CONFIGURATION IS COMPLETE  
              PLEASE RESET SWITCH POWER  
              FOR CHANGES TO TAKE EFFECT

## DISPLAY FUNCTIONS

An NTI RACKMUX with a 17" monitor supports resolutions up to SXGA (1280 x 1024) with a refresh rate at between 55 and 76Hz. When a 15" monitor is present, support for resolutions up to XGA (1024 x 768) apply with a refresh rate at between 55 and 76Hz. The quality of the image on the LCD monitor is adjustable using an On Screen Display (OSD) menu using the control buttons on the RACKMUX.

### Standard Controls

The RACKMUX has 5 standard control buttons and a power LED. The 5 standard control buttons operate as follows:

- The **Power** button turns the RACKMUX LCD and backlight ON and OFF as desired.
- The **Power LED** located immediately below the Power button is a dual color LED. It will illuminate with a green color when the RACKMUX is powered ON and working properly. It will illuminate with a red color if the RACKMUX is powered ON but there is no input signal detected.
- The **Menu** button is used to bring up the OSD menu where the various settings of the LCD display can be adjusted. Once the OSD screen is displayed, the Menu button is used to make selections within the menus. See "OSD Control Menu" (below) for more on LCD display settings.
- The **Up and Down Arrow** buttons are used to navigate through the menus. Move the cursor up or down as desired to highlight an item for selection. Once an item is highlighted, pressing the Menu button will select it.

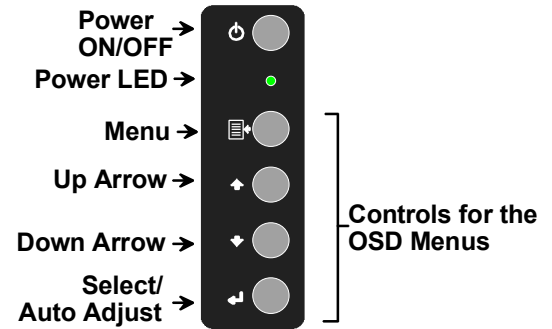

Figure 18- OSD Controls

- The **Select** button is used to make selections within the OSD menus when the OSD menu is ON. When the OSD menu is OFF, the Select button will act as an **Auto Adjust** button to keep the user from having to use the menus to adjust the quality of the image on the monitor.

### OSD Control Menu

The OSD (On Screen Display) Menu enables the user to select the desired characteristics of the LCD display. To activate the OSD Menu, press the Menu button (above). To turn the Menu back OFF, either select "EXIT" from the main menu or just wait 10-60 seconds and it will automatically be cleared from the screen.

#### OSD Main Menu



Selection	Purpose	Range
Brightness/Contrast	Increase/decrease panel brightness/contrast level	1-100
Color	R,G,B color temperature control	1-100
Position	<ul style="list-style-type: none"> <li>• Video Image horizontal and vertical position control</li> <li>• Clock setting</li> <li>• Phase control</li> </ul>	1-100
Setup	<ul style="list-style-type: none"> <li>• Control OSD Image position on screen</li> <li>• Set time OSD will stay on screen before auto shutoff</li> <li>• Select the language of the OSD menu</li> </ul>	-- 10 to 60 seconds Several languages (see page 8)
Exit	Exit from the OSD control menu	

### Brightness/Contrast Menu

Selecting the Brightness/Contrast menu will bring up a screen in which the user can adjust the brightness and contrast levels of the LCD display. Using the Up or Down arrows to navigate the menu, highlight either the BRIGHTNESS or CONTRAST sections and press the Select button to choose the option to adjust. Then use the Up or Down Arrow to adjust the setting. Select EXIT when finished to return to the Main Menu.



### Color Menu

Selecting the Color menu will bring up a screen in which the user can adjust the Red, Green, and Blue color levels (values from 1-100) of the LCD display. With the RED, GREEN, or BLUE sections highlighted, (use the Up or Down arrow to move between them), press the Select button to choose the option to adjust. Then use the Up or Down Arrow to adjust the setting. Select EXIT when finished to return to the Main Menu.

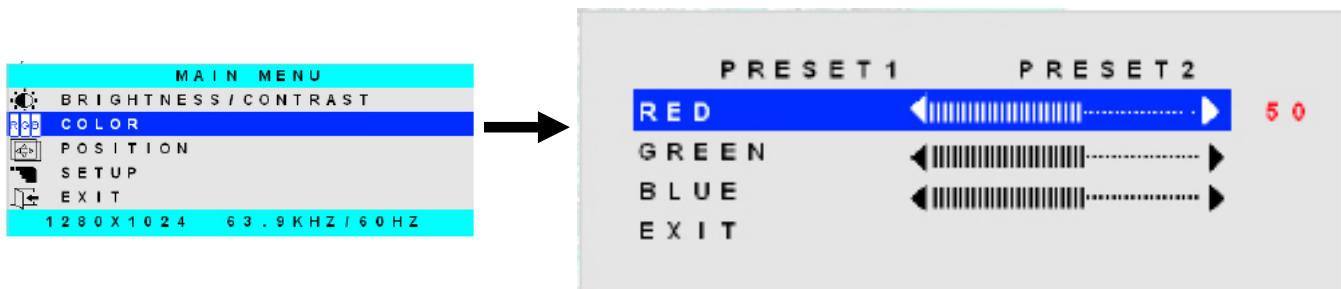

### Position Menu

Selecting the Position menu will bring up a screen in which the user can select AUTO ADJUST to automatically adjust the horizontal and vertical position of the displayed image on the monitor, as well as adjust the clock and phase settings if they are not correct. The user can also individually adjust these settings if so desired. With any of the sections highlighted, (use the Up or Down arrow to move between them), press the Select button to choose the option to adjust. Then use the Up or Down Arrow to adjust the setting as needed. Select EXIT when finished to return to the Main Menu.

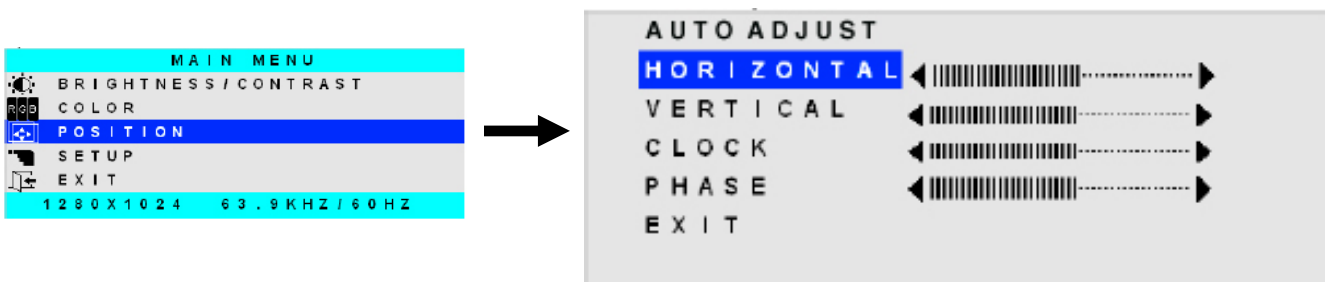

## Setup Menu

Selecting the Setup menu will bring up a screen in which the user can adjust

- OSD POSITION-the position of the OSD menus on the LCD display
- OSD TIME-the length of time the user can be idle before the OSD menu automatically exits (adjustable from 10 to 60 seconds)
- LANGUAGE-the language that the OSD menus will be presented in

With the item highlighted, (use the Up or Down arrow to move between them), press the Select button to choose the option to adjust. Then use the Up or Down Arrow to adjust the setting as needed. Select EXIT when finished to return to the Main Menu.

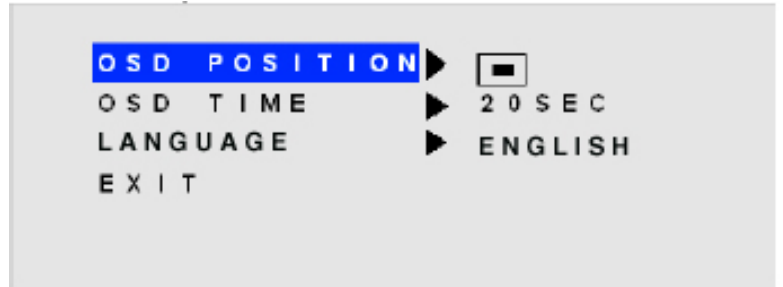
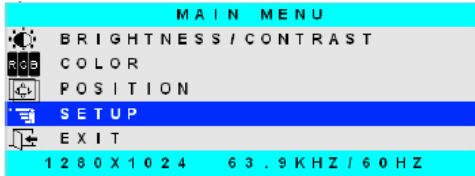

OSD Image can be moved to different points on the display

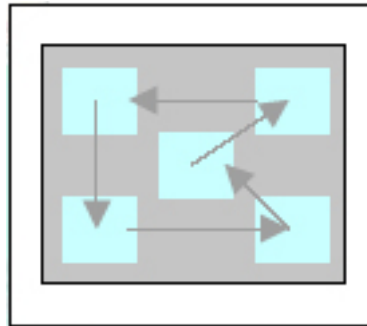

## KEYBOARD FUNCTIONS

### RACKMUX-V15-x

The keyboard on the RACKMUX-V15-x (and RACKMUX-V17-x) is a standard condensed Windows format. To reduce the keyboard size, some keys have been assigned multiple functions, accessible via the "Fn" key. This section will describe which keys have multiple functions and how to enable them. Use the LEDs to know what special features are enabled.

### Function Key Operation

The Function ("Fn") key provides several special functions on the RACKMUX keyboard, including:

- enabling otherwise standard keyboard keys to be used as the keys of a numeric keypad
- enabling multi-function keys to change operation

To turn ON (lock) the Function key, press the "Fn" key twice quickly (double-click). The "Fn" LED will illuminate.

To turn OFF (unlock) the Function key, press the "Fn" key twice quickly again. The "Fn" LED will turn OFF.

**Note: The "Fn" key will also operate similar to the shift key (with only momentary effect). Press and hold the "Fn" key prior to pressing the special function key. The "Fn" key will remain active as long as it is depressed.**

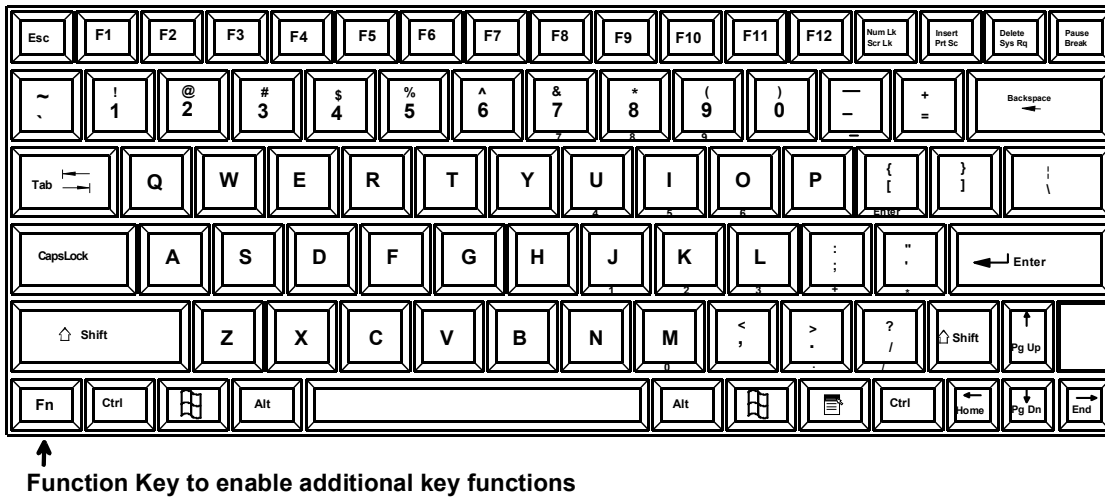

Figure 19- US(English) Keyboard Layout

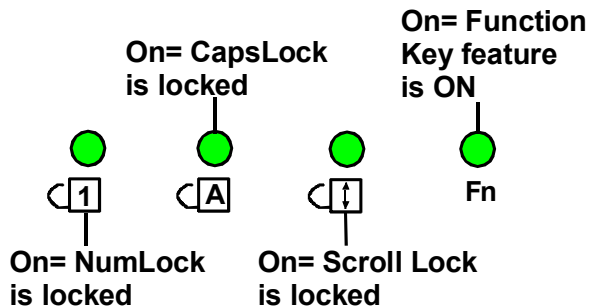



Figure 20- Keyboard LED Indications

## Number Pad

The functionality of a Number Pad on a standard Windows keyboard has been incorporated into the keyboard of the RACKMUX-V15. To substitute the keys of the Number Pad

To substitute the keys of the Number Pad: 

1. Press the "NumLock" key. The NumLock LED (  ) will illuminate.
2. Press the "Fn" key twice quickly (double-click). The "Fn" LED will illuminate.

To turn OFF Number Pad functions:

1. Press the "Fn" key twice quickly (double-click). The "Fn" LED will turn OFF.
2. Press the "NumLock" key. The NumLock LED (  ) will turn OFF.

With the Fn and NumLock LEDs illuminated, pressing some standard keys will result in displaying characters as indicated in the chart below.

Standard Key	Displayed when NumLock is ON	Function when NumLock is OFF
J	1	End
K	2	Down Arrow
L	3	Page Down
U	4	Left Arrow
J	5	---
O	6	Right Arrow
7	7	Home
8	8	Up Arrow
9	9	Page Up
M	0	Insert
.	.	Delete
/	/	/
(forward slash)	(forward slash)	(forward slash)
;	+	+
(semicolon)	(plus sign)	(plus sign)
'	*	*
(apostrophe)	(asterisk)	(asterisk)
-	-	-
(hyphen)	(minus sign)	(minus sign)
[	ENTER	ENTER
(left bracket)	ENTER	ENTER

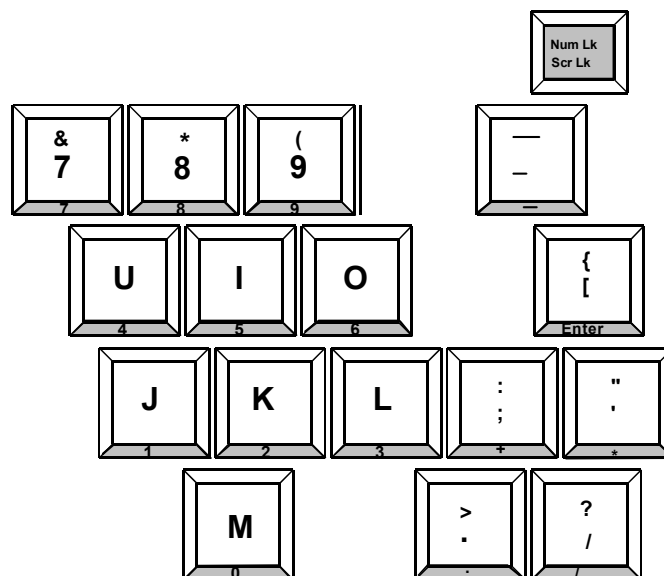

Figure 21- Keys of the Number Pad

## Other Functions of the "Fn" Key

The Function ("Fn") key will enable other standard keyboard features in addition to the Number Pad keys (page 25) .

Key Function when Fn key is not locked ("Fn" LED is OFF)	Key Function when Fn key is Locked ("Fn" LED is ON)
Numlck (Number lock)	Scr Lck (Scroll Lock)
Insert	Prt Sc (Print Screen)
Delete	Sys Rq (System Requirements)
Pause	Break
Up Arrow	Page Up
Down Arrow	Page Down
Left Arrow	Home
Right Arrow	End

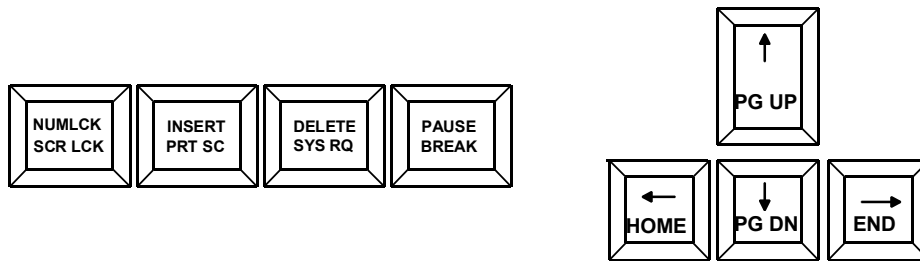

Figure 22- Additional multi-function keys

**Note:** The "Fn" key will also operate similar to the shift key (with only momentary effect).

## Numeric Keypad Option

Models with the Numeric Keypad option (-N) (i.e. RACKMUX-V15-N-8UNV) have a standard Windows keyboard with 17-key numeric keypad.

**Note:** The “Fn” key is not an active key on this keyboard.

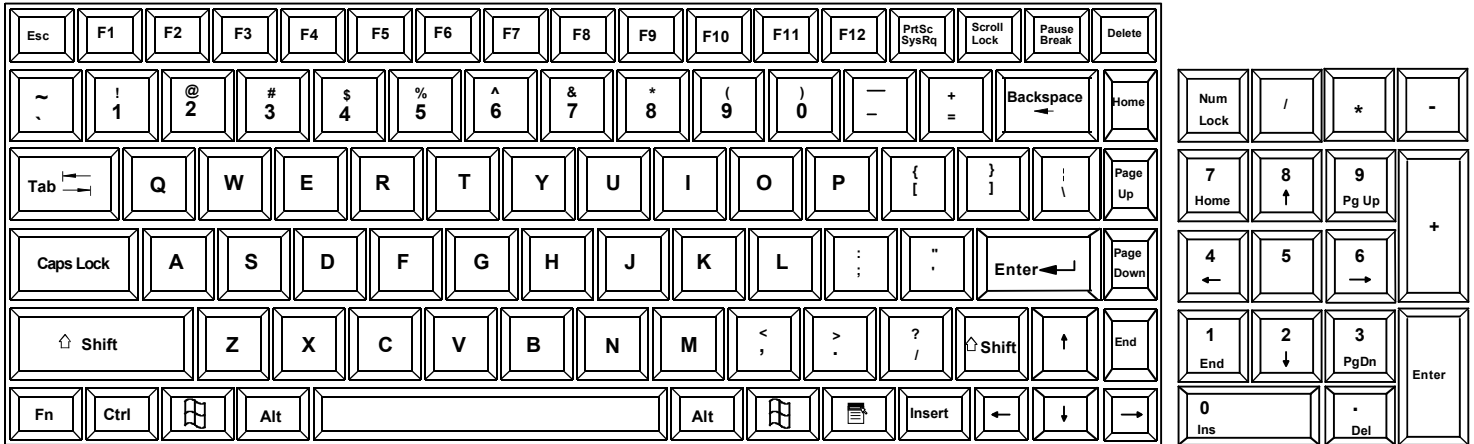

Figure 23- U.S. (English) keyboard with numeric keypad

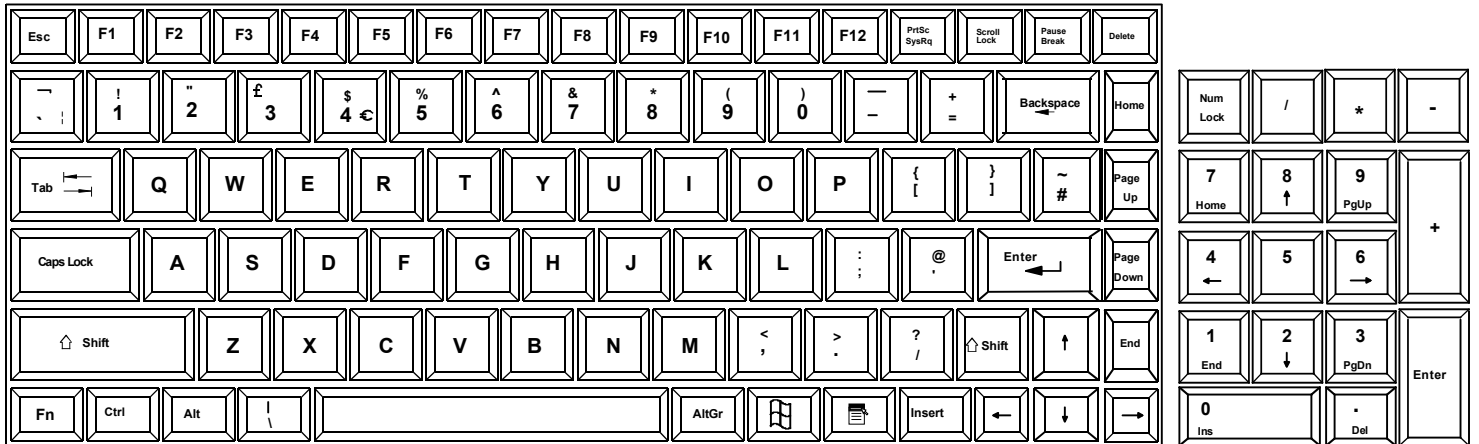

Figure 24- U.K. (English keyboard with numeric keypad)

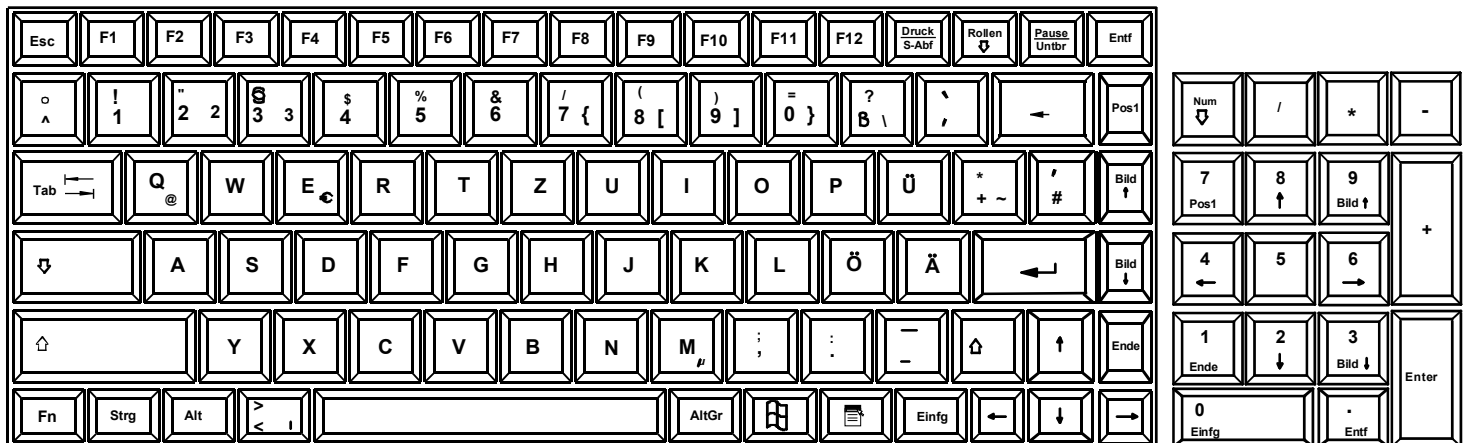

Figure 25- German keyboard with numeric keypad

## KEYBOARD FEATURES

The keyboard configuration of each CPU is saved in the NODEMUX switch. For example, if the CPU attached to Port 2 had CAPS LOCK and NUM LOCK selected the last time that CPU was accessed, then they will automatically be set when that CPU is accessed again.

### Keyboard-To-Computer Translation

The NODEMUX switch enables a mixture of otherwise incompatible peripheral computer components to be connected together. This is accomplished by performing keyboard-to-computer translations automatically (i.e. translate the Windows keyboard and mouse to a SUN type CPU). The chart below shows the capabilities of the keyboard controlling certain CPU types.

#### Translation Capabilities

<i>Device</i>	<b>CPU</b>		
	<i>Sun</i>	<i>Mac</i>	<i>Windows</i>
<b>RACKMUX Keyboard</b>	Extra keys emulation	Power key emulation	Full functionality

#### Translation Tables

Use the charts below to type SUN's additional keys with the RACKMUX keyboard:

##### **SUN Extra Keys**

<b>RACKMUX keyboard</b>	<b>Sun Extra Keys</b>
Space Bar + F1	Stop
Space Bar + F2	Again
Space Bar + F3	Props
Space Bar + F4	Undo
Space Bar + F5	Front
Space Bar + F6	Copy
Space Bar + F7	Open
Space Bar + F8	Paste
Space Bar + F9	Find
Space Bar + F10	Cut
Space Bar + F11	Help
Space Bar + F12	Compose
Space Bar + Up Arrow	Volume +
Space Bar + Down Arrow	Volume -
Space Bar + Left Arrow	Mute

##### **Power Key Emulation**

<b>RACKMUX Keyboard</b>	<b>Mac CPU</b>	<b>Sun CPU</b>
Space Bar + RT Arrow	Power	Power

## TROUBLESHOOTING

**PROBLEM:** Keyboard Errors  
**SOLUTION:** Check cable connections on each CPU and the switch.

**PROBLEM:** No Video  
**SOLUTION:** Check cable connections on each CPU and the switch. Verify that keyboard and video connect from each CPU to matching ports. After reconnecting, CPU may need to be re-booted in order to sense the monitor connection.

**PROBLEM:** No OSD  
**SOLUTION:** The administrator may have configured the unit as a slave instead of stand-alone switch. OSD will not work when a NODEMUX is configured as a slave. To reconfigure the switch to a stand-alone configuration, see RS232 Control , "CF" command on page 20.  
**BE SURE TO READ WARNING BEFORE USING THIS COMMAND.**

**PROBLEM:** No Keyboard or Mouse  
**SOLUTION:** Shut down CPU's. Power cycle the switch. Turn on CPU's.

## DEFAULT PASSWORD RESET

In the event the Administrator password is lost or forgotten, the password can be reset to the default password of **ADMINISTRATOR**. Figure 26 shows the location of the password reset button.

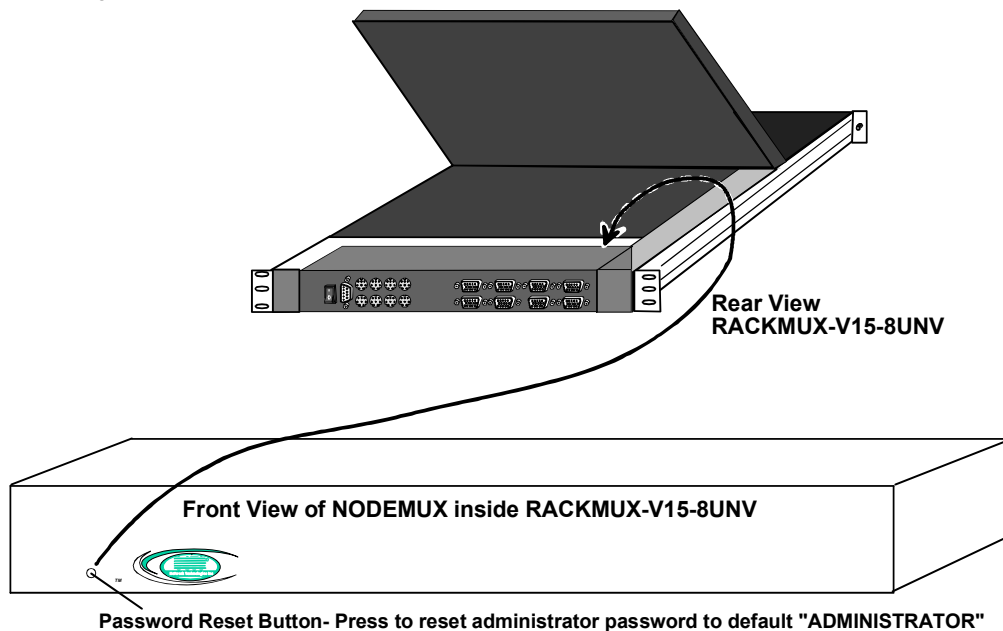

**Figure 26- Locating the password reset button**

To reset the password;

1. Turn the power OFF to the NODEMUX.
2. Press and hold the password reset button. (Stick something non-conductive into the small opening to depress the button inside.)
3. Turn the power ON to the NODEMUX.
4. Release the password reset button.

For instruction on how to change the default administrator password, see page 10.

## RACKMUX-KVM DRAWER STANDARD SPECIFICATIONS

### General Specs

Case Material.....	Electro-galvanized steel black powdercoated
Dimensions WxDxH (in.).....	19 x 21.9 x 1.75
Supported Rack Depths.....	Adjustable 22" – 39"
Input Power.....	AC 100-240V, 50 – 60 Hz
Operating Temperature.....	0-40°C
Storage Temperature.....	-20-60°C
Relative Humidity.....	20-90%, non-condensing
Approvals.....	All parts comply with RoHS

### LCD – 15"

Display area.....	304.1mm (W) x 228.1 (H) (15 inch diagonal)
Panel Type.....	TFT Active
Number of Pixels.....	1024 (H) x 768 (V)
Number of Colors.....	16.2 Million
Pixel Pitch.....	0.297(H) x 0.297(V)
Color Pixel Arrangement.....	RGB Vertical Stripe
Brightness.....	250cd/m <sup>2</sup> (Nits)
Response Time.....	16ms
Viewing Angle.....	Horizontal: 140°; Vertical: 125° (Typ.)
Optimum Viewing Direction.....	6 o'clock
Backlight Unit.....	2x CCFLs (Top & Bottom, edge-light)
Operating Lamp Life.....	30,000 – 40,000 hrs
Contrast Ratio.....	500:1

### LCD – 17"

Display area.....	337.92mm (W) x 270.336 (H) (17 inch diagonal)
Panel Type.....	TFT Active
Number of Pixels.....	1280 (H) x 1024 (V)
Number of Colors.....	16.2 Million (6 bits + FRC)
Pixel Pitch.....	0.264(H) x 0.264(V)
Color Pixel Arrangement.....	RGB Vertical Stripe
Brightness.....	300cd/m <sup>2</sup> (Nits)
Response Time.....	5.5ms
Viewing Angle.....	Horizontal: 140°; Vertical: 130° (Typ.)
Optimum Viewing Direction.....	6 o'clock
Backlight Unit.....	CCFL, 4 Tables, Edge-Light (2 Top/2 Bottom)
Operating Lamp Life.....	40,000 – 50,000 hrs
Contrast Ratio.....	500:1

### Display Controller: VGA (-15 & -17)

Connector.....	15HD, female
Video Format.....	VGA, SVGA, XGA, SXGA (17" only)
Signal Input (from Video Source).....	Analog RGB
Sync Range.....	H: 31 ~ 80KHz, V: 55 ~ 76Hz
OSD Control.....	Menu, Up, Down, Select, Power (5 keys)
Plug and Play.....	VESA DDC 2B Ver1.3

### OSD Control Board

OSD Control.....	5 Keys
Power Key.....	Power ON/OFF
Menu Key.....	Activates Menu
Up, Down Keys.....	Navigation Control
Select Key.....	Select (when in Menu); Auto Adjust (not in menu)
LED.....	Indicates Operation Status
.....	Green = Power-ON, Video Input OK
.....	Red = Suspend / Stand-by, or Input Out of Range

## Keyboard

No. Of Keys .....	83 Keys (US), 84 keys (German, French, Italian, Spanish)
Key Switch Type .....	Membrane switch
Keytop Style.....	Rectangular Cylindrical
Operating Force.....	50gf +/- 25gf
Stroke .....	3.0mm +/- .5mm
Tactile .....	20 gf typ.
Height .....	8.5 mm
Operating Life .....	10M operations, minimum
Interface .....	Row and column matrix
Key Switch Bounce.....	10 ms, maximum

## Touchpad

Motion Detection Method .....	capacitance sensing
X/Y Position Sensing Resolution .....	40 counts/mm
X/Y Position Reporting.....	Relative (Similar to mouse)
Tracking Speed.....	Up to 1016 mm/sec
Touch Force.....	No Contact pressure required
Lifetime (Plastic Overlay).....	Minimum 10,000,000 strokes
Sample Rate .....	Up to 100 samples/sec

## INDEX

<b>A</b> Administration Mode, 8	materials list, 2
<b>A</b> Administrator password change, 10	<b>N</b> umber Pad, 25
Broadcast Mode, 13	numeric keypad, 27
<b>C</b> ommand Mode, 11	<b>O</b> SD Control, 7
configure baud rate, 17	OSD Controls, 21
connect cables, 4	passwords, 7
Default password reset, 29	Power-up Sequence, 6
<b>D</b> isplay functions, 21	rack installation, 4
Edit Mode, 13	<b>R</b> S232 Control, 16
Fn key, 24	Scan Mode, 13
<b>F</b> unction key, 24	Search Mode, 14
Keyboard Control, 7	<b>S</b> ecurity, 7
Keyboard LEDs, 24	Specifications, 30
keyboard translation, 28	<b>S</b> witch configuration, 9
LEDs, 24	System Access list, 11
loop back, 17	User access, 11
<b>M</b> aintenance Mode, 15	User Name list, 10

## WARRANTY INFORMATION

The warranty period on this product (parts and labor) is two (2) years from the date of purchase. Please contact Network Technologies Inc at **(800) 742-8324** (800-RGB-TECH) or **(330) 562-7070** or visit our website at <http://www.networktechinc.com> for information regarding repairs and/or returns. A return authorization number is required for all repairs/returns.